

120V N-Ch Power MOSFET

Feature

- ◇ High Speed Power Switching
- ◇ Enhanced Body diode dv/dt capability
- ◇ Enhanced Avalanche Ruggedness
- ◇ 100% UIS Tested, 100% Rg Tested
- ◇ Lead Free, Halogen Free

V_{DS}	120	V
$R_{DS(on),typ}$	1.8	m Ω
I_D (Silicon Limited)	341	A

Application

- ◇ Synchronous Rectification in SMPS
- ◇ Hard Switching and High Speed Circuit
- ◇ DC/DC in Telecoms and Industrial

TOLL

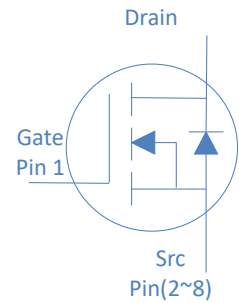

Part Number	Package	Marking
HGT022N12S	TOLL	GT022N12S

Absolute Maximum Ratings at $T_j=25^\circ\text{C}$ (unless otherwise specified)

Parameter	Symbol	Conditions	Value	Unit
Continuous Drain Current (Silicon Limited)	I_D	$T_C=25^\circ\text{C}$	341	A
		$T_C=100^\circ\text{C}$	241	
Drain to Source Voltage	V_{DS}	-	120	V
Gate to Source Voltage	V_{GS}	-	± 20	V
Pulsed Drain Current	I_{DM}	-	1200	A
Avalanche Energy, Single Pulse	E_{AS}	$L=0.4\text{mH}, T_C=25^\circ\text{C}$	720	mJ
Power Dissipation	P_D	$T_C=25^\circ\text{C}$	600	W
Operating and Storage Temperature	T_J, T_{stg}	-	-55 to 175	$^\circ\text{C}$

Absolute Maximum Ratings

Parameter	Symbol	Max	Unit
Thermal Resistance Junction-Ambient	$R_{\theta JA}$	60	$^\circ\text{C/W}$
Thermal Resistance Junction-Case	$R_{\theta JC}$	0.25	$^\circ\text{C/W}$

Electrical Characteristics at $T_j=25^\circ\text{C}$ (unless otherwise specified)
Static Characteristics

Parameter	Symbol	Conditions	Value			Unit
			min	typ	max	
Drain to Source Breakdown Voltage	$V_{(BR)DSS}$	$V_{GS}=0V, I_D=250\mu A$	120	-	-	V
Gate Threshold Voltage	$V_{GS(th)}$	$V_{GS}=V_{DS}, I_D=250\mu A$	2.0	2.9	4.0	
Zero Gate Voltage Drain Current	I_{DSS}	$V_{GS}=0V, V_{DS}=120V, T_j=25^\circ\text{C}$	-	-	10	μA
		$V_{GS}=0V, V_{DS}=120V, T_j=100^\circ\text{C}$	-	-	100	
Gate to Source Leakage Current	I_{GSS}	$V_{GS}=\pm 20V, V_{DS}=0V$	-	-	± 100	nA
Drain to Source on Resistance	$R_{DS(on)}$	$V_{GS}=10V, I_D=20A$	-	1.8	2.2	m Ω
Transconductance	g_{fs}	$V_{DS}=5V, I_D=20A$	-	90	-	S
Gate Resistance	R_G	$V_{GS}=0V, V_{DS}$ Open, $f=1\text{MHz}$	-	1.0	-	Ω

Dynamic Characteristics

Input Capacitance	C_{iss}	$V_{GS}=0V, V_{DS}=60V, f=1\text{MHz}$	-	10810	-	pF
Output Capacitance	C_{oss}		-	1347	-	
Reverse Transfer Capacitance	C_{rss}		-	20	-	
Total Gate Charge	$Q_g(10V)$	$V_{DD}=60V, I_D=20A, V_{GS}=10V$	-	140	-	nC
Gate to Source Charge	Q_{gs}		-	40	-	
Gate to Drain (Miller) Charge	Q_{gd}		-	20	-	
Turn on Delay Time	$t_{d(on)}$	$V_{DD}=60V, I_D=20A, V_{GS}=10V, R_G=10\Omega,$	-	30	-	ns
Rise time	t_r		-	20	-	
Turn off Delay Time	$t_{d(off)}$		-	51	-	
Fall Time	t_f		-	15	-	

Reverse Diode Characteristics

Diode Forward Voltage	V_{SD}	$V_{GS}=0V, I_F=20A$	-	0.9	1.2	V
Reverse Recovery Time	t_{rr}	$V_R=60V, I_F=20A, di_F/dt=100A/\mu s$	-	95	-	ns
Reverse Recovery Charge	Q_{rr}		-	209	-	nC

Fig 1. Typical Output Characteristics

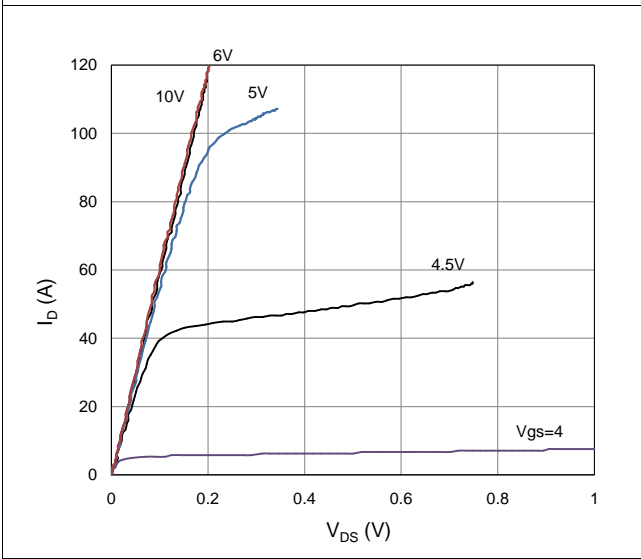

Figure 2. On-Resistance vs. Gate-Source Voltage

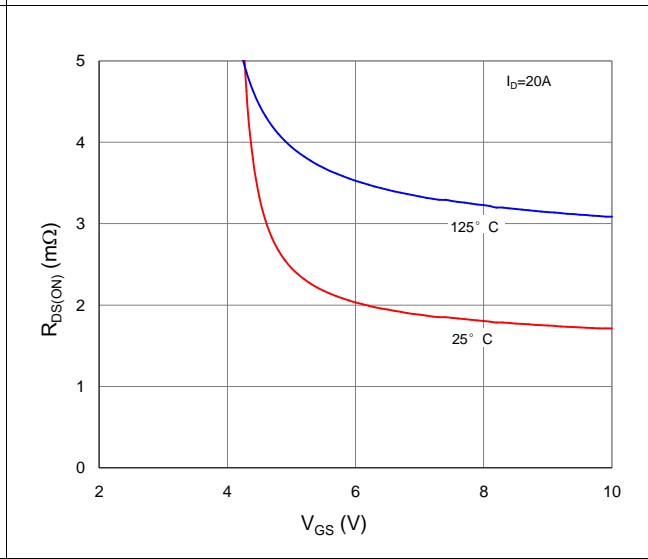

Figure 3. On-Resistance vs. Drain Current and Gate Voltage

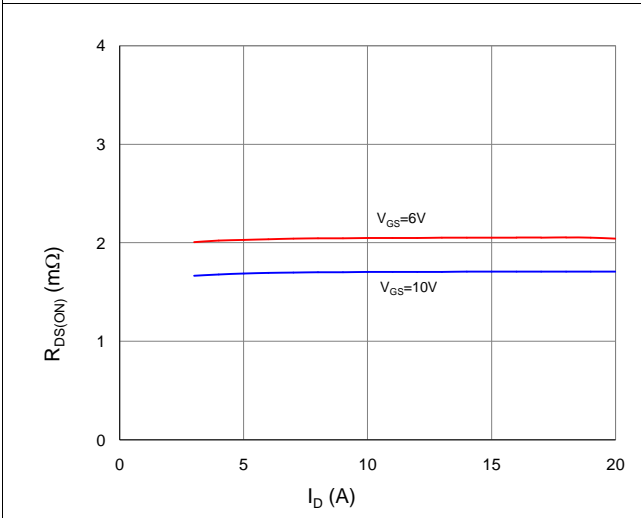

Figure 4. Normalized On-Resistance vs. Junction Temperature

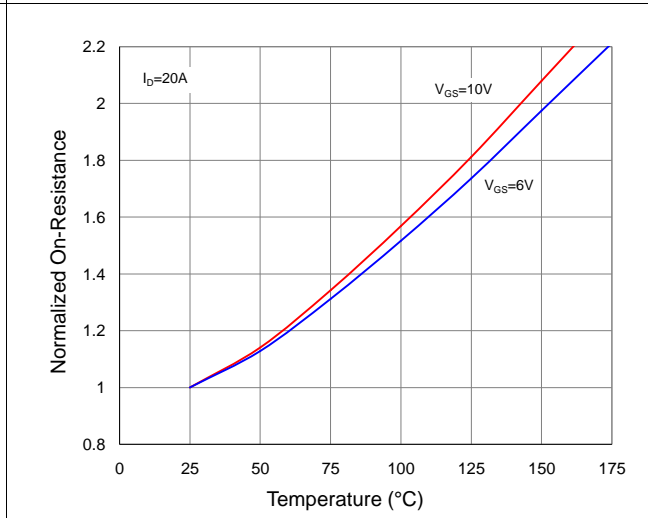

Figure 5. Typical Transfer Characteristics

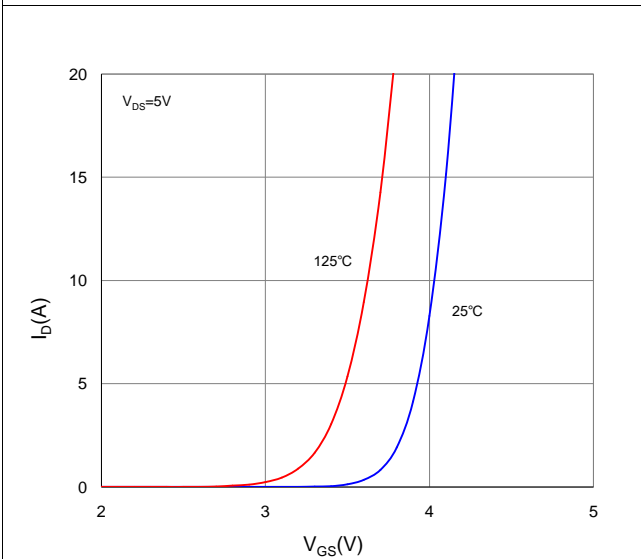

Figure 6. Typical Source-Drain Diode Forward Voltage

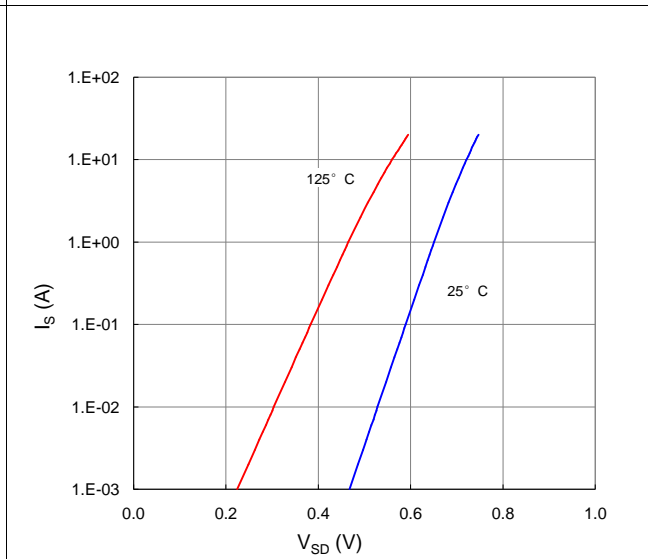

Figure 7. Typical Gate-Charge vs. Gate-to-Source Voltage

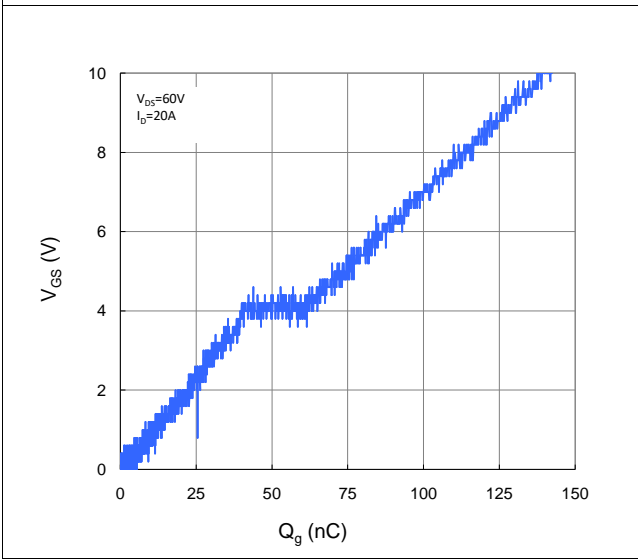

Figure 8. Typical Capacitance vs. Drain-to-Source Voltage

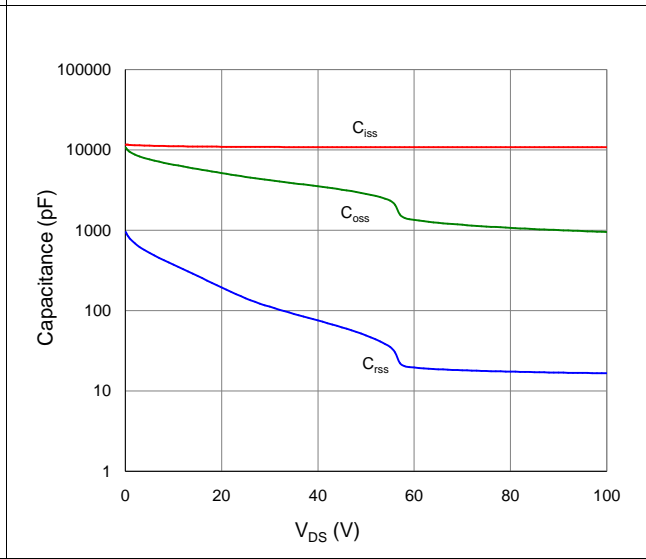

Figure 9. Maximum Safe Operating Area

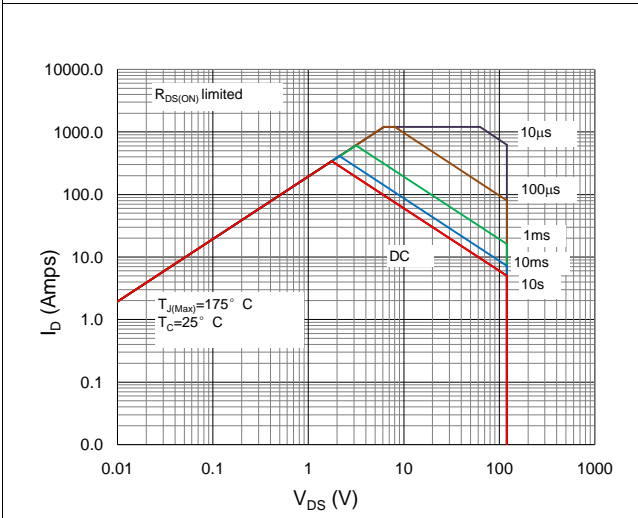

Figure 10. Maximum Drain Current vs. Case Temperature

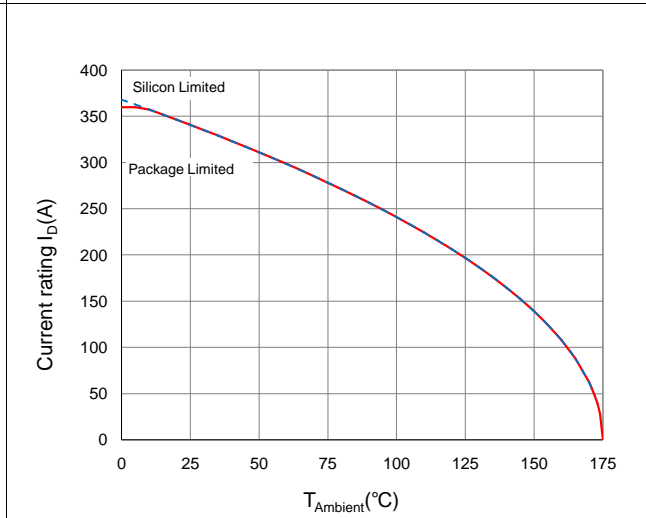
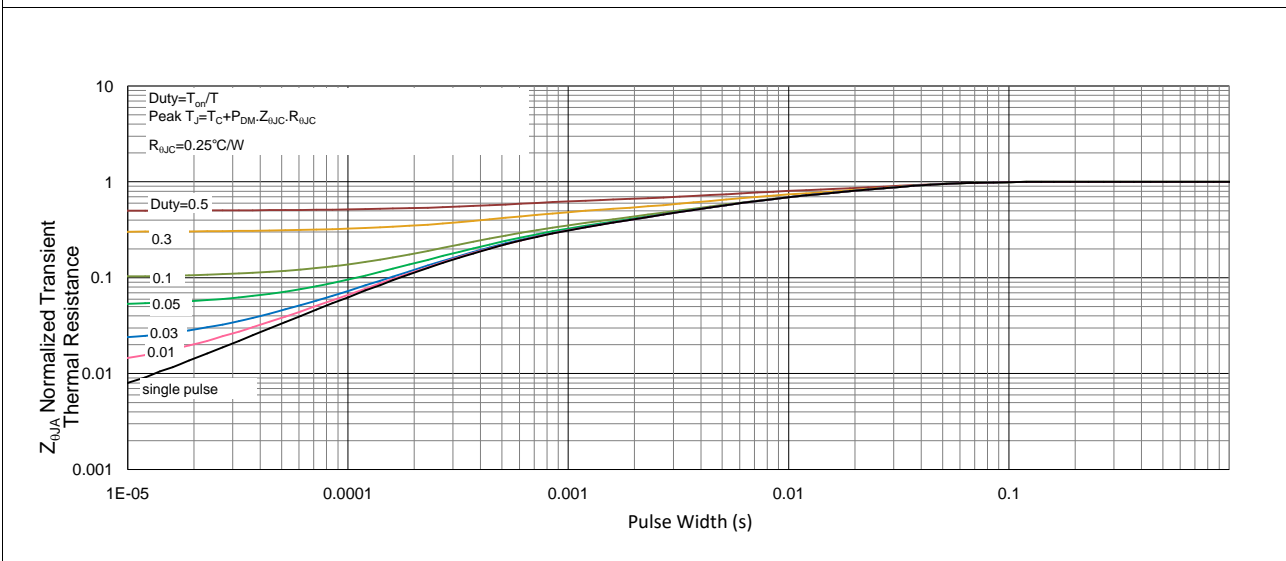
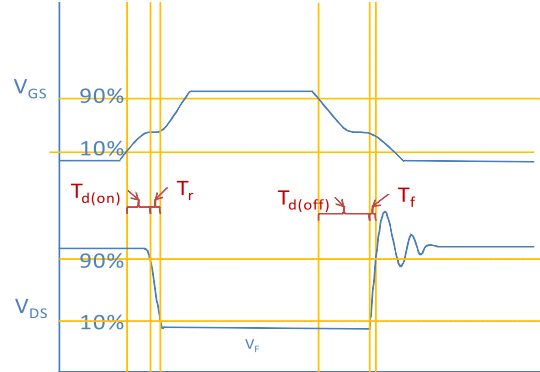
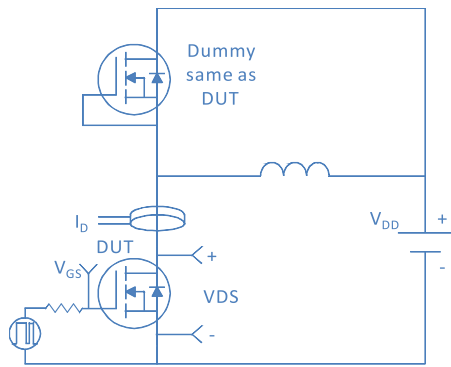

Figure 11. Normalized Maximum Transient Thermal Impedance, Junction-to-Ambient



Inductive switching Test



Gate Charge Test

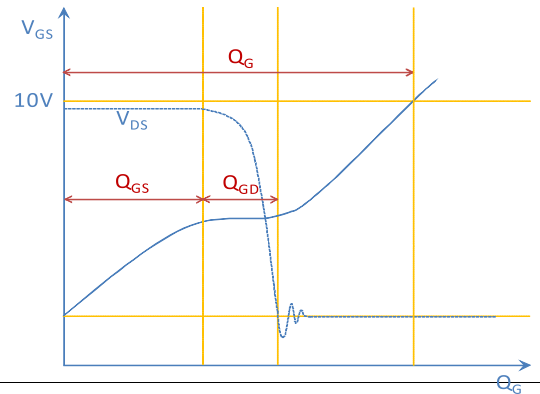
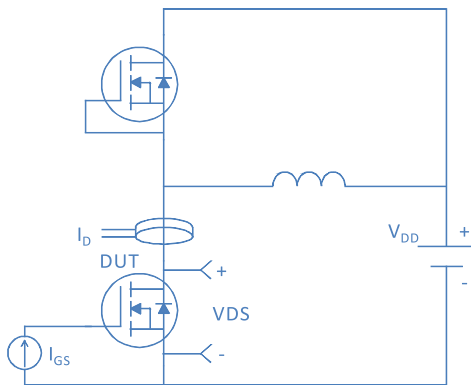

Uclamped Inductive Switching (UIS) Test

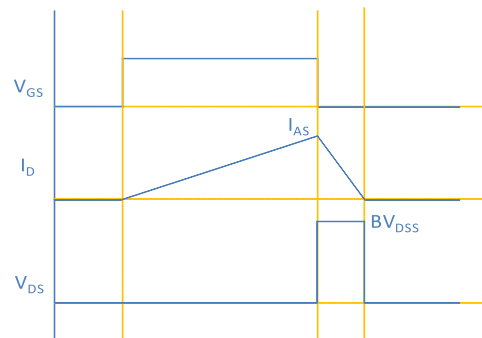
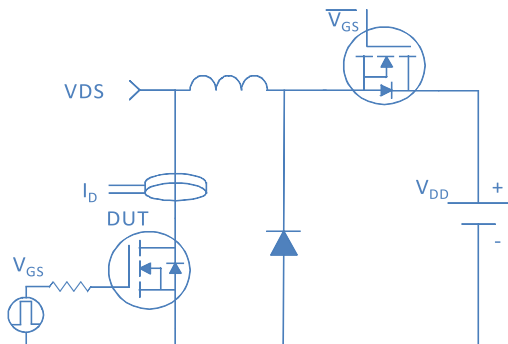

Diode Recovery Test

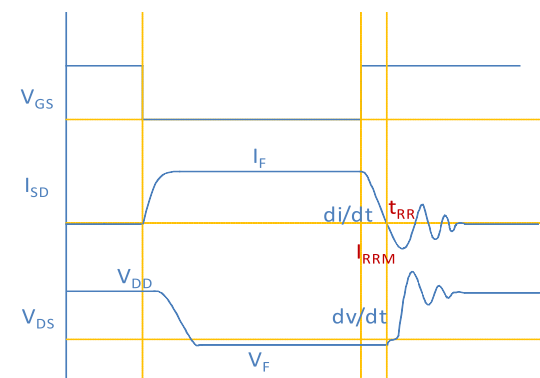
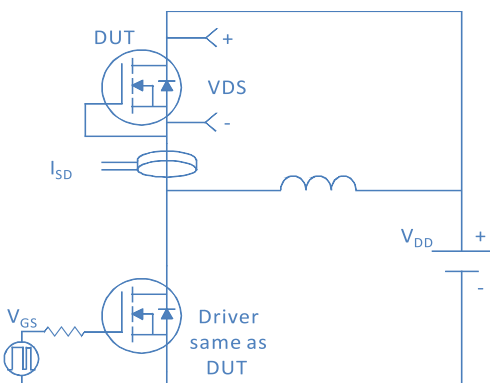

Package Outline

TOLL, 8 leads

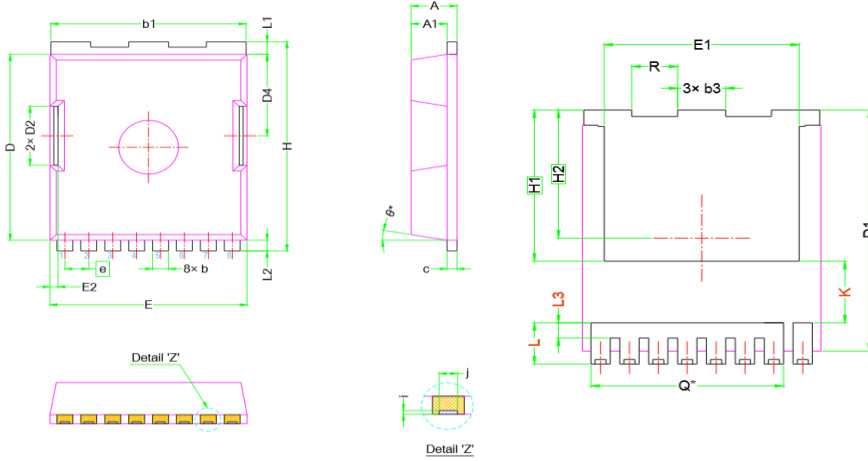

SYMBOL	DIMENSIONS		
	MIN.	NOM.	MAX.
A	2.20	2.30	2.40
A1	1.70	1.80	1.90
b	0.70	0.80	0.90
b1	9.70	9.80	9.90
b3	1.90	2.00	2.10
c	0.40	0.50	0.60
D	10.28	10.38	10.48
D1	10.98	11.08	11.18
D2	3.20	3.30	3.40
D4	4.45	4.55	4.65
E	9.80	9.90	10.00
E1	8.00	8.10	8.20
E2	0.30	0.40	0.50
e	1.20 BSC		
H	11.58	11.68	11.78
H1	6.95 BSC		
H2	5.89 BSC		
i	0.10 REF.		
j	0.46 REF.		
K	2.80 REF.		
L	1.60	1.90	2.10
L1	0.60	0.70	0.80
L2	0.50	0.60	0.70
L3	0.60	0.70	0.80
N	8		
Q	6.80 REF.		
R	1.80	1.90	2.00
θ	10° REF.		